

DARAY®



SL180LED

**CEILING, WALL AND MOBILE
INSTALLATION AND
OPERATING MANUAL**

DARAY®

CONTENTS

1. GENERAL DESCRIPTION	4
2. SPECIFICATION	5
SERIAL NUMBERS AND LABELLING	5
3. OPERATION	6
4. MAINTENANCE	7
CLEANING AND DISINFECTING	7
ROUTINE MAINTENANCE	7
5. ADJUSTMENT OF ARM TO PREVENT DRIFT	9
6. INSTALLATION	10
Installation - Ceiling mount	10
Installation - Wall mount	16
Assembly - Mobile	18
Installation - Fit the jib-joint cover (all models)	20
Installation - Fitting the head (all models)	21
7. FUSE REPLACEMENT	22
8. SPARE PARTS	22
RETURNS POLICY	23
WARRANTY INFORMATION	24
WARRANTY REGISTRATION	25

Tel: 0844 375 9000

Fax: 0333 321 0973

www.daray.com

info@daray.com

1. GENERAL DESCRIPTION

The DARAY SL180LED is a high-quality LED medical minor surgical light available as wall, ceiling and mobile versions. The SL180LED has variable intensity with an aesthetic, robust and efficient light-head.

The SL180LED is for use during minor surgical procedures in GP surgeries, hospital day surgeries, health-centres and veterinary practices.

Its 4,200K colour temperature ensures the natural colour of flesh tones is not distorted.

DARAY's BioProtect[®] anti-microbial coating is applied to the light-head, handle and the suspension arm system. All other surfaces are smooth to aid cleaning and sterilisation.

The light comprises 3 parts: a ceiling, wall or mobile mounting, a variable-intensity power-supply module containing a transformer to convert mains voltage to a safe low voltage to power the light, and a suspension arm with fitted light-head.

There are 2 versions of the power-supply module: one for use where the mains-electrical supply cables are 'chased' into a wall, and the other fitted with an IEC inlet so the mains may be supplied via a plug-in flex from a standard mains socket. The power-supply module is fastened underneath the wall-mount bracket for the SL180LEDW and can be screwed to the wall to power the SL180LEDC.

2. SPECIFICATION

Light output at 0.75m	0 - 65,000 lux @ 0.75m ± 5%
Colour temperature	4,200K natural white light
Power consumption	15W
LED module operating voltage	30V DC
Input voltage	230V 50Hz
Arm reach	1650 mm
Jib arm vertical movement	+15° /-45°
Quality approvals	CE
Medical-device directive	93/42/EEC, EN60601-2-41

Serial Numbers and Labelling

Each SL180LED is allocated a unique serial number located on the mounting arm, and is identified by a label also affixed to the arm.

The power-supply module carries its own identification and serial number.

3. OPERATION

If you have a ceiling mounted SL180LED, go straight to step 2.

1. Check that the mains indicator is illuminated on the power supply module.

If the mains indicator does not illuminate, check the mains supply and then the fuses in the module which are located on its right-hand side. For models powered via an IEC lead with a moulded mains plug, check the fuse in the mains plug.

2. Operate the light using the rocker switch on the light-head near the handle. This is a momentary type switch and does not latch.

- Press the switch once to turn the light ON
- Press and hold to decrease intensity
- Press and hold to increase intensity
- Press the switch once again to turn the light OFF

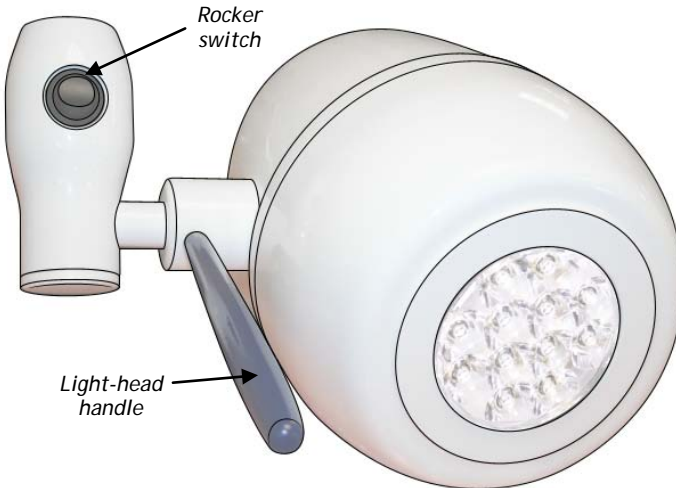

Note: If mains power is removed, the intensity will be reset to its brightest setting when mains power is restored.

Use the handle to steer the light-patch to where you want it; in the interests of cross-infection control, avoid touching any other part of the light.

The suspension arm swivels at the mounting and at the joint between the primary and jib arms. The jib arm allows the light-head to be moved up and down. The light-head itself can rotate 320° on the jib arm in both vertical and horizontal axes.

After use, switch off at the light-head switch and also, where applicable, at the power-supply module on the wall.

Warning: Mobile Models - only move the light using the handle on the up-stand.

4. MAINTENANCE

Cleaning and Disinfection

WARNING: do not use strong chemical cleaning agents to sterilise the light. Do not use any abrasive materials to clean the light.

CAUTION the light is not waterproof, so do not use excessive cleaning fluid amounts.

Suitably protect hands.

Wipe the light using clean tissue or soft towelling - pay special attention to the switch areas.

On all surfaces, apply a 1% solution of sodium hypochlorite using a soft cloth. Within 10 minutes, remove the chemical from all surfaces using a damp, soft cloth. The chemical will cause corrosion of metal parts, if it is not thoroughly removed.

Apply Isopropanol to the surfaces - this is an alcohol-based fluid which evaporates without leaving any residue and can be obtained as an impregnated-cloth applicator.

Do not autoclave the light-head steering handle, as it may damage the BioProtect® coating.

Routine Maintenance

The SL180LED is designed and manufactured to stringent quality standards. Observing the following procedures will help to maintain the light's optimum performance.

Light-head

Clean all exterior surfaces as required using the directions above.

Arm

Operation	Suggested Intervals	Details
On wall-mounted units, lift the arm so its spigot is almost clear of the bush in the wall-mount plate and re-lubricate if required.	Six monthly	
On ceiling mount units, support the arm and remove the 3 screws retaining the fitting adaptor into the downtube. Lower the arm until the adaptor and key can be removed. Slide sleeve up and inspect for lubrication. Lubricate spigot and sleeve if required.	Six monthly	
Check tightness of all 5 fixing screws.	Annually	
Check balance of jib over the whole range of movement.	One month after installation and then annually	If tendency is to fall from fully up, insert key in capstan hole furthest away and with jib fully up move capstan by pulling key towards you. Repeat until no fall at top. Reverse capstan if rise at bottom of jib movement.

Ceiling Mount

Operation	Suggested Intervals	Details
Inspect 6 socket screws for tightness and check that washers are fitted under head.	Six monthly	Tighten with appropriate hex wrench
Check that down post is rigidly mounted to the ceiling (do not exert undue force).	Annually	If any movement found - immediately advise your full service dealer

Wall Mount

Operation	Suggested Intervals	Details
Check for security of fixing to wall	Annually	Investigate any looseness - ensure your building contractor is consulted if looseness found

Mobile Mount

Operation	Suggested intervals	Details
Light-head Clean all exterior surfaces	As required	Disinfecting and cleaning directions - see above
Arm Check tightness of all fixing screws	Annually	
Check balance of jib over whole range	One month after installation and then annually	

5. ADJUSTMENT OF ARM BALANCE TO ELIMINATE DRIFT

Insert a small implement (e.g. hex wrench 2mm AF) into one of the holes and turn capstan in the direction of Arrow A until desired balance is obtained.

Note: To eliminate rise in the jib at the fully down position turn the capstan in the opposite direction to Arrow A.

To assist in making this adjustment, it may be necessary to remove the arm joint cover: Remove the 2 snap in plugs and the 2 screws, allowing the cover half mouldings to be separated and the moving cover to slide down the jib arm. This provides better access to the slot through which the capstan nut is adjusted.

Note: When re-assembling, ensure that the moving cover is correctly positioned with the 'T' notation on the component at the 'Top'.

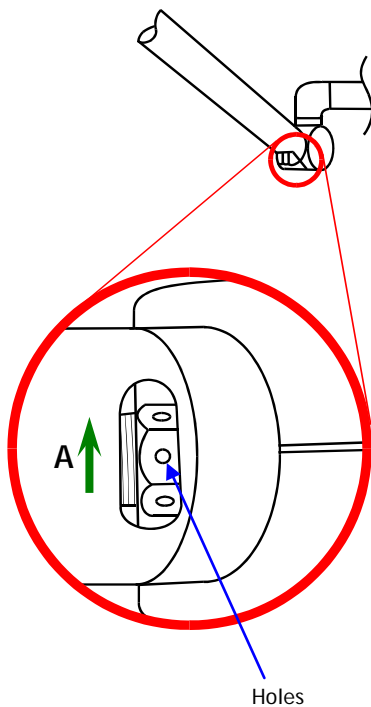

6. INSTALLATION

Installation - Ceiling Mount

CAUTION: this product must be earthed.

Check you have the following items:

Ceiling-mount plate assembly and cover
Down-tube
Light-head on suspension arm
Down-tube bungs
Down-tube grub-screw
Down-tube spigot nylon washer
Grease sachet

Determine where to mount light from the positioning and ceiling-load forces diagrams, below:

WARNING: please note that this information is provided for guidance only and that a qualified builder or structural engineer should be consulted if you have any doubt about the suitability of the proposed mounting position.

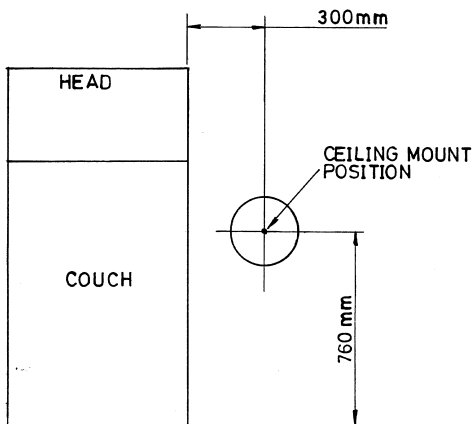

WARNING: the light-head operates from a low-voltage supply produced by a transformer in the ceiling mount assembly and fed through the suspension arm. On NO ACCOUNT should the arm be connected directly to mains voltages.

Fitting the ceiling plate

Remove the clamp bolts, safety bolt/nylon insert nut and the clamp. Keep these parts in a safe place for use later.

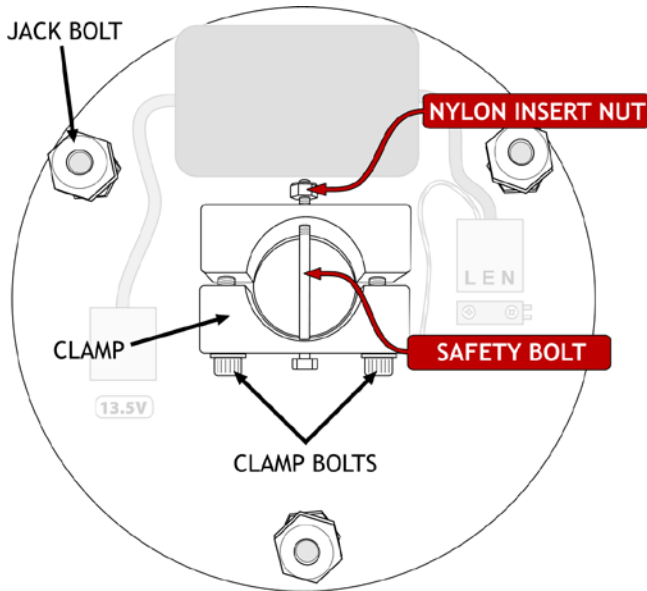

Fix the plate to the ceiling with bolts, screws or studs and nuts through the centre of each jack bolt. Do not fully tighten the fasteners at this point.

Note: The nuts thread-locked to the upper end of the 3 jack bolts act as pressure pads. These pressure pads must be seated firmly against the mounting surface.

The jack bolts can then be used to adjust the position of the ceiling plate and down-tube.

Fitting the Down-tube

A 1 metre length of down-tube is included with all ceiling mount kits, and must be securely fitted in accordance with these instructions.

The down-tube should be cut to length on-site to suit the particular ceiling height and application.

Note when installed the down-tube must leave clearance above the ceiling mount plate to prevent the cable being trapped.

For determining the cut point, we suggest measuring the distance between the ceiling mounting plate, and a point about 1900mm above the floor.

The length of the down-tube should be altered to suit the room dimensions and the particular application for which the light is to be used.

De-burr as necessary.

NOTE: For suspended ceilings, the ceiling hole trim and retaining band should be placed over the downtube BEFORE proceeding.

Loosely refit the clamp and clamp bolts. Fit the down-tube in the clamp and tighten the clamp bolts to firmly hold it in place. Drill a 6mm hole completely through the tube via the guide holes in the clamp and fit the safety bolt and nylon insert lock nut supplied.

NOTE: TO ENSURE THE USER'S SAFETY, THE SAFETY BOLT AND NYLON INSERT LOCK NUT MUST BE FITTED PROPERLY

Feed the end of the low-voltage cable assembly through the tube.

Tighten both clamp screws fully and evenly until the tube is firmly clamped.

Adjust the 3 large bolts such that the down-tube is absolutely vertical. Tighten the fixing bolts or screws to firmly clamp the jack bolts tight against the joist, tighten the thin locknuts and re-check that the down-tube remains vertical, and the mounting plate has no movement. If necessary, repeat the adjustment.

Run the low-voltage cable to the mounted power-supply module, feed it through the grommet on the top of the module and connect it to the 2-way terminal block wired to the low-voltage output from the transformer.

Refit the module to its mounted rear plate.

NOTE: For suspended ceilings cut a clearance hole in a ceiling tile, replace the tile and slide the trim up the downtube until it is firmly against ceiling tile, then roll the trim retaining band upward until it holds the trim in position.

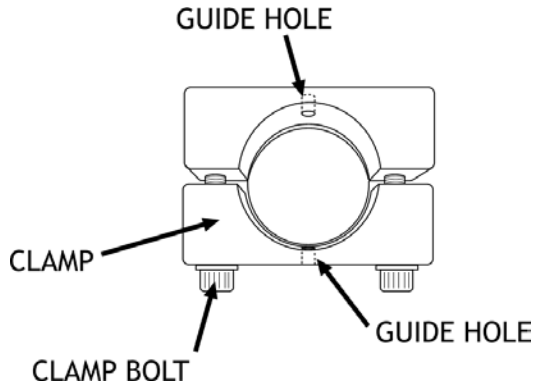

NOTE: For conventional ceilings fit the cover, holding it in place with the retaining band from the fitting kit.

Install the primary arm



To ensure the smooth rotation of the arm, it is essential that the primary arm spigot is **lightly** lubricated before assembly.
A sachet of silicon grease is provided.

Place the nylon washer over the primary arm spigot.

Insert the primary arm spigot into the down-tube.

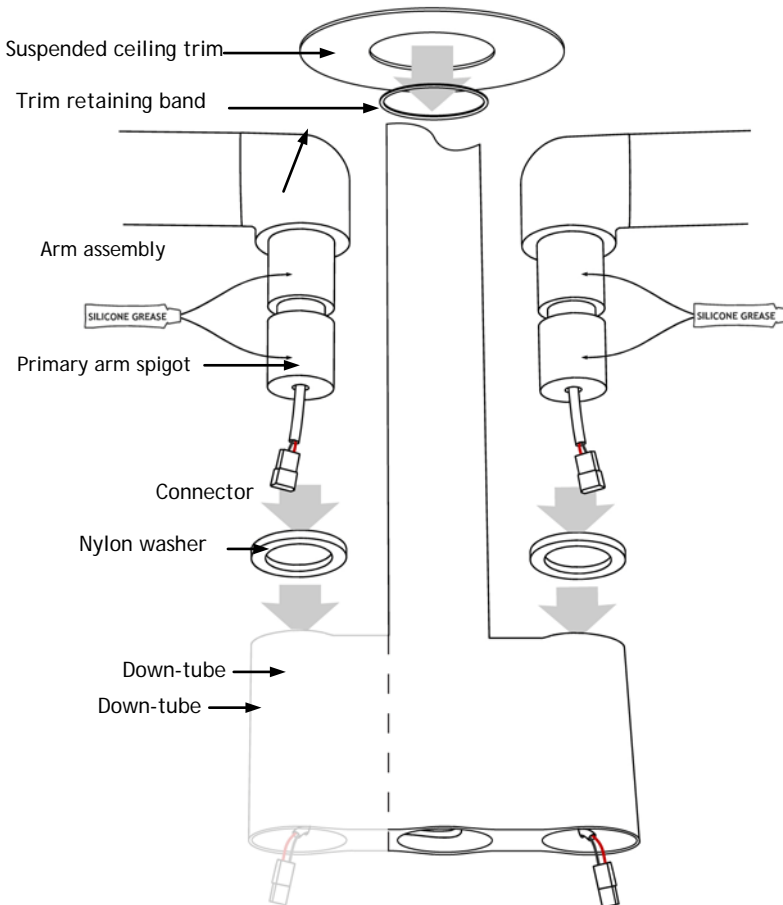

Join the connector from the primary arm to the connector from the down-tube.

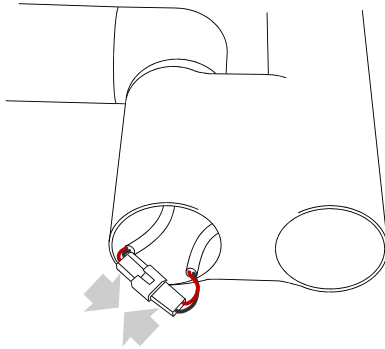

Fit the supplied bungs.

Make sure to sit the joined connectors inside the bung before fitting to prevent the cable from being damaged.

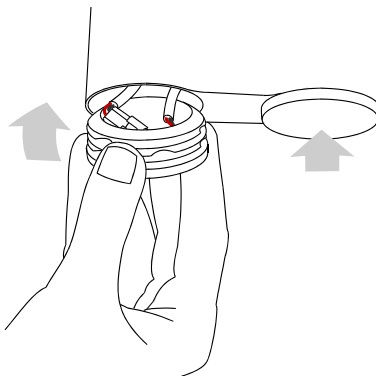

Fit the jib-joint cover (see p.20).

Fit the light-head (see p.21).

Check everything for tightness and safety.

Check the arm and head for freedom of movement.

Rebalance the jib arm if necessary (see p.9).

Wiring the SL180LEDC

Provide a suitable, earthed switched fused spur.

Run a 1.5mm² twin and earth cable to the ceiling plate 230V terminal block.

Provide power to the spur.

Turn on the light with the rocker switch on its mounting swivel (see section 3 *Operation*) and check that the light illuminates.

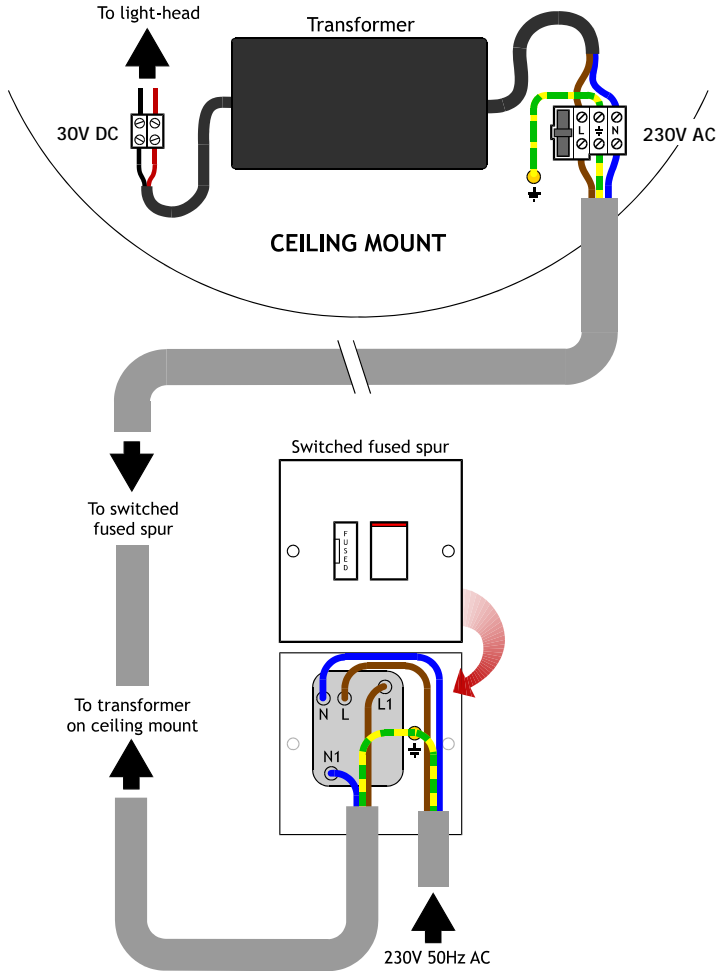

SL180LEDC wiring diagram

Installation - Wall Mount

CAUTION: this product must be earthed.

Check you have the following items:

Wall-mount plate
Light-head on suspension arm
Power supply module

Determine where to mount the wall bracket. For general medical examination use, we suggest that the top of the bracket where the primary arm fits into should be about 2000mm above the floor. For other specific applications, mount the wall bracket in a location so that, when fitted, the light-head is at the required height.

WARNING: Consult a building engineer, if in doubt.

Secure the plate to the wall, ensuring that it is truly vertical.

WARNING: the light-head operates from a low-voltage supply produced by a transformer in the power-supply module and fed through the suspension arm. On NO ACCOUNT should the arm be connected directly to mains electricity.

Fit the power-supply module directly under the wall plate.

Remove the rear plate from the power-supply module by slackening the screw in each of the 4 corners.



To ensure the smooth rotation of the arm, **lightly** grease the spigot on the primary arm with the silicone grease provided. Slide the spigot into the bracket on the wall-mount plate, feeding the low-voltage cable from the primary arm through the top of the power-supply module.

Connect the low-voltage cable to the **2-way** terminal block wired to the low-voltage output from the transformer.

The power-supply module requires an earthed 230V AC electrical supply either fed into its rear or into a socket/switched fused spur on the side depending on the module supplied.

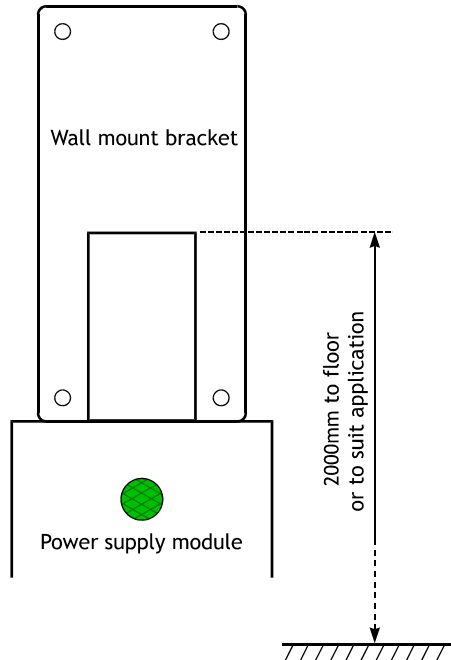

Connect the incoming mains cable to the **3-way** 'LEN' terminal block in the module.

Fasten the module's earth-bond wire to the rear-plate's earth stud.

Refit the module to its mounted rear plate.

Fit the jib-joint cover (see p.20).

Fit the light-head (see p.21).

Check everything for tightness and safety.

Check the arm and head for freedom of movement.

Rebalance the jib arm, if necessary.

Provide power to the power-supply module and check that the mains indicator illuminates.

Operate the variable intensity control module by pressing it. Rotate to dim. Check that the light-head illuminates and that the intensity control works.

Assembly - Mobile Mount

Fit the lower section of the up-stand to the base, mating the locating peg on the lower up-stand section with its associated hole on the base.

Fit the socket-head screw through the screw cover base and screw tightly into the up-stand using a hex wrench.

Fit the screw cover cap.

Refer to the 'peel-off' assembly marks as shown.

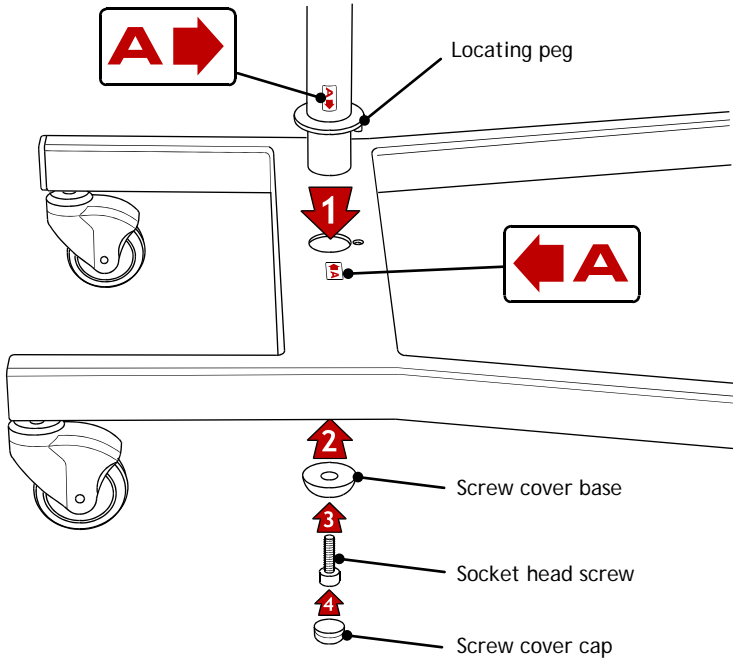

Fit the upper section of the up-stand to the lower section of the up-stand with the screw and shake-proof washer using the hex wrench provided.

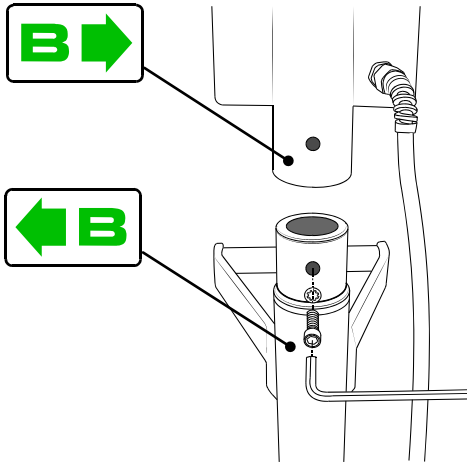

Wrap the flex around the cable holders

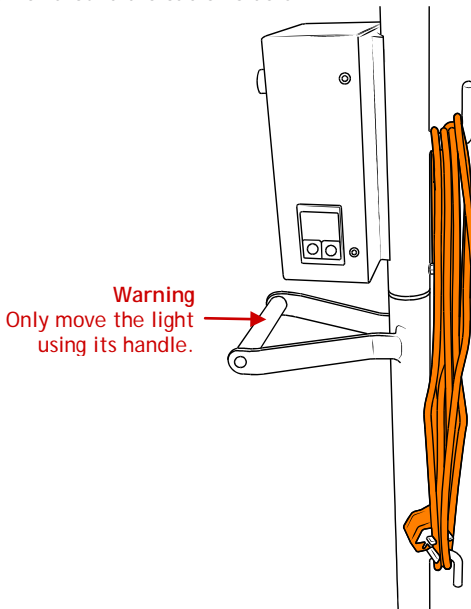

Fit the jib-joint cover (see p.20).

Fit the light-head (see p.21).

Installation - Fit the jib-joint cover

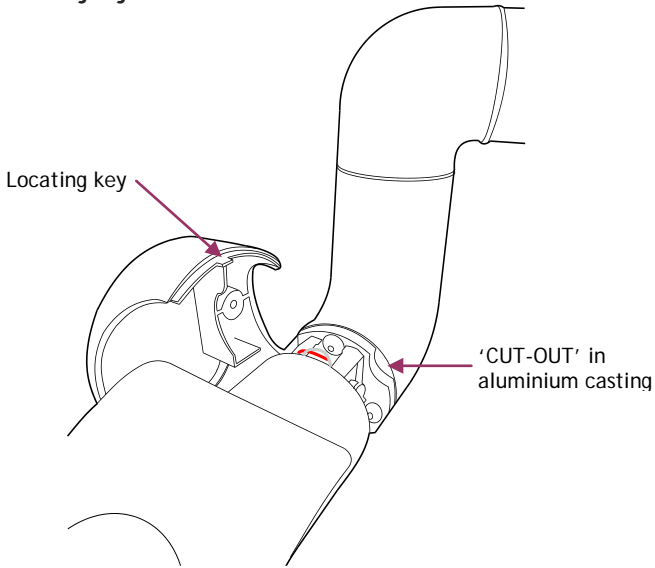

1. Covers are marked 'L' and 'R' on their inside faces as viewed from the end of arm. Engage the slider, with its 'T' mark uppermost, into the groove inside the cover.

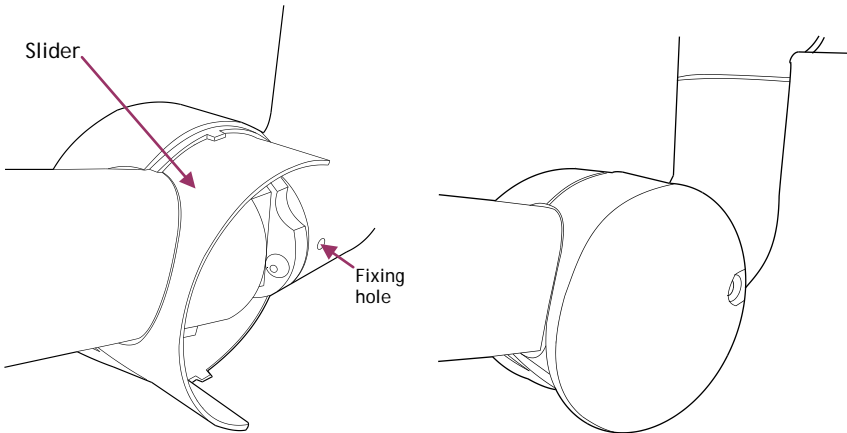

2. Align holes in cover and painted elbow. 'Nip up' the screw to secure.
DO NOT OVERTIGHTEN
3. Fit opposite cover
DO NOT OVERTIGHTEN
Fit a plug in each hole
4. Carefully check the operation of arm and the jib-joint cover.

Installation - Fitting the light-head

Connect the light-head connector to the connector in the arm

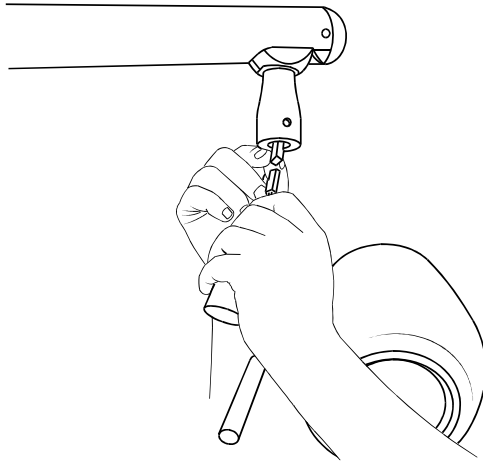

Apply a little grease to the light-head spigot and insert it into the arm, being careful not to trap the cable/connector.

Supporting the light-head in one hand, tighten the locking grub-screw with the hex key provided.

NOTE: Make sure the grub-screw is not too tight preventing the light-head from rotating.

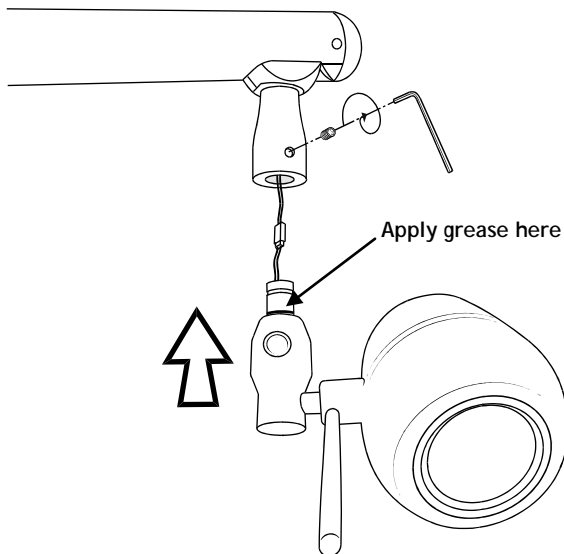

7. FUSE REPLACEMENT

CAUTION: fuses normally blow for a reason. Investigate likely faults before changing fuses.

CAUTION: isolate the unit from the mains before accessing the fuses.

Both the live and neutral mains inputs are fused. The fuses are contained in a holder which is part of the IEC inlet mounted on the rear panel of the mobile base.

Using a flat-blade screwdriver, or similar, pull forward the 'drawer' containing the fuses.

Hinge down the front of the holder.

Lift the fuses by pushing them through the holes below them.

Refit new fuses and reverse the removal sequence, ensuring the 'drawer' is pushed fully home.

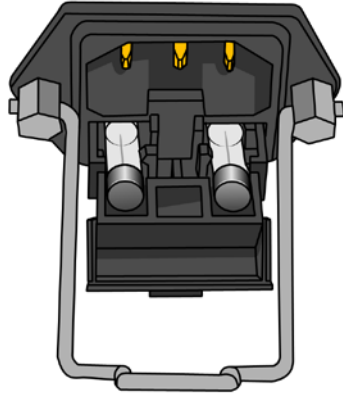

8. SPARE PARTS

CAUTION: Use only genuine DARAY replacement lamps as other types may seriously impair the optical performance of the product.

ITEM NO	PART NAME	TYPE	PART NO
1	Fuse	1A 20mm	D10873
2	Microfibre cloth	5 pack	DRK4080

RETURNS POLICY

IMPORTANT!

Before returning your item, you must call us on 0844 375 9000

We want you to be completely satisfied with your purchase. If you need to return goods purchased from DARAY Ltd, please read the following information carefully.

The DARAY Ltd returns policy provides guidance on when you can return goods we have supplied, and what you can expect from us once you do. To see our detailed returns policy and procedure visit www.daray.co.uk/returns

TYPE OF RETURN	REMEDY
DAMAGED GOODS OR DOA* Goods which are physically damaged on delivery, or which do not function.	We must be notified within 24 hours of receipt.
GOODS DEVELOPING A FAULT Goods which have developed a fault within the warranty period.	Within 14 days of delivery we will replace the item as DOA*. If the fault develops after 14 days, but within the warranty period, we will initiate the returns procedure.
NON WARRANTY Goods which have developed a fault outside the warranty period.	If a fault develops outside the warranty period, we will initiate the returns procedure.
OTHER Any situation which is not covered by any of the above.	We will try to help, but we cannot normally offer a refund.

*DOA - dead on arrival

For additional clarification, please refer to our terms and conditions at www.daray.co.uk/terms.

In a small number of cases, we may determine that a replacement would not work any better than the original product we supplied. In such cases we will only offer a refund rather than a replacement for qualifying returns.

Replacement bulbs are not eligible for returns, unless they are faulty or damaged.

Spare parts ordered on our website or from supplied part codes are not be eligible for credit. We will accept returns and exchange for the correct item.

If you send us goods that do not qualify for return, you will invalidate your claim to any refund, and you will be obliged to compensate DARAY Ltd for the cost of return postage and any other reasonable costs incurred processing the goods.

Your statutory rights are not affected.

WARRANTY INFORMATION

DARAY's products come with a 12 months 'return to manufacturer' warranty (excluding bulbs, consumable and spare parts). However, we understand that some installed lights would be difficult to send back to us. Therefore, in the unlikely event you experience a problem with one of lights you we can arrange for one of our engineers to visit your premises to inspect the light, to minimise downtime. This service is chargeable, although any parts used would still be covered under our normal warranty terms and conditions. Please contact our customer services team on **0844 375 9000** for further details.

Our 12 months warranty may be extended for most of our lighting products from 3 to 5 years, free of charge by returning a completed, pre-paid registration card included with the product. Alternatively complete and submit the warranty registration form below.

Our aftercare plan has been designed to offer complete piece-of-mind for at least three years (aftercare does not include consumables or spare parts).

- Year 1 - parts and labour (return to base)
- Year 2 - parts only
- Year 3 - parts only

For more information on our terms and conditions, returns policy and how to return warranted goods please go to our website www.daray.co.uk (see the 'Support' item in the main menu) or alternatively call DARAY Customer Services on **0844 375 9000**.



WARRANTY REGISTRATION
 TO VALIDATE YOUR WARRANTY
 PLEASE COMPLETE IN BLOCK CAPITALS
 AND RETURN IN A WINDOWED DL ENVELOPE
 TO OUR FREEPOST ADDRESS

ALTERNATIVELY REGISTER ONLINE AT WWW.DARAY.COM



5 YEAR AFTER-CARE PLAN

NAME:

COMPANY:

EMAIL:

PHONE:

FAX:

ADDRESS:

PURCHASED FROM:

DATE OF PURCHASE:

Freepost Plus RRAS-YGXE-SLBC
 Daray Ltd
 Marquis Drive
 SWADLINCOTE
 DE12 6EJ

Occasionally DARAY would like to send you information about our special offers and promotions. If you do not wish to receive such information, please tick here:

Privacy statement: DARAY will not pass on your details to any third party.

PRODUCT:

SERIAL No:

DARAY Ltd

Marquis Drive · Moira ²⁵ Derbyshire · DE12 6EJ

Tel: 0844 375 9000 · Fax: 0333 321 0973